

INFIRAY OUTDOOR
RICO HD SERIES

Rugged Infrared Compact Optic



WARNING! ITAR REQUIREMENTS

These products may be subject to export and foreign trade control laws of the United States and may not be exported without prior approval of the U.S. Department of State.

Learn more at irayusa.com/ITAR.

FCC ID: 2AYGT-29-00

This device complies with part 15 of the FCC Rules. Operation is subject to the following two conditions: (1) This device may not cause harmful interference, and (2) this device must accept any interference received, including interference that may cause undesired operation.

CAUTION: Changes or modifications not expressly approved by IRayUSA could void the user's authority to operate the equipment.

NOTE: This equipment has been tested and found to comply with the limits for a Class B digital device, pursuant to part 15 of the FCC Rules. These limits are designed to provide reasonable protection against harmful interference in a residential installation. This equipment generates, uses and can radiate radio frequency energy and, if not installed and used in accordance with the instructions, may cause harmful interference to radio communications. However, there is no guarantee that interference will not occur in a particular installation. If this equipment does cause harmful interference to radio or television reception, which can be determined by turning the equipment off and on, the user is encouraged to try to correct the interference by one or more of the following measures:

- Reorient or relocate the receiving antenna.
- Increase the separation between the equipment and receiver.
- Connect the equipment into an outlet on a circuit different from that to which the receiver is connected.
- Consult the dealer or an experienced radio/TV technician for help.

This device was tested for typical body-supported operations and use. To comply with RF exposure requirements, a minimum separation distance of 0.5cm must be maintained between the user's body and the handset, including the antenna. Third-party belt-clips, holsters, and similar accessories used by this device should not contain any metallic components. Body accessories that do not meet these requirements may not comply with RF exposure requirements and should be avoided. Use only the supplied or an approved antenna.

TABLE OF CONTENTS

1. Overview	2
2. Features	2
3. Tech Specs.....	3
4. Accessories.....	4
5. Components and Controls	5
6. Description of Control Buttons and Shortcuts.....	6
7. Quick Start Guide.....	8
8. Charging the Battery Pack	10
9. Installing the Battery Pack.....	11
10. Removing the Battery Pack.....	12
11. Battery Safety Warnings.....	12
12. External Power Supply	13
13. Mounting the RICO RS75.....	13
14. Operating Instructions.....	14
15. Zeroing the RICO HD Series.....	20
16. Non-Uniformity Correction.....	20
17. Photography and Video Recording.....	22
18. Accessing the Internal Memory	23
19. Connecting to WiFi	24
20. Using the InfiRay Outdoor App	26
21. Digital Zoom	27
22. Picture in Picture (PIP)	27
23. Ultra-Clear Mode.....	28
24. Main Menu Options and Descriptions	28
25. Basic Inspection	46
26. Basic Maintenance	46
27. Warranty.....	46
28. General Troubleshooting	47

1. OVERVIEW

The RICO HD Series RS75 from InfiRay Outdoor marks a new chapter in thermal technology. Featuring an industry-first 1280×1024 12μm sensor, an ultra-high resolution 1.03-inch 2560×2560 AMOLED display, low-distortion orthoscopic eyepiece, and a 75mm f/1.0 lens, the RS75 is the perfect blend of optical performance and sensor resolution. The RICO HD also offers crystal-clear onboard audio recording and 128 GB of storage so you can capture each countdown and relive every impact. With the RS75, InfiRay Outdoor has finally unleashed capabilities that night hunters had previously only dreamed of.

2. FEATURES

- 12μm high-performance thermal detector
- High image quality
- Aluminum alloy housing
- Maximum detection range 3600 yards
- Quick-change rechargeable battery pack
- HD 2560×2560 AMOLED display
- High frame frequency: 30Hz
- Multiple zero profiles and ranges
- Digital Zoom: ×2/×4/×8/×16
- Built-in 128 GB storage to support image capture and video recording
- Built-in WiFi module
- Mobile device App compatible
- Built-in digital compass and gravity sensor
- Multiple reticle types and color options
- Ultra-Clear mode for advanced image detail
- Picture in Picture (PIP)
- User-friendly interface
- Pixel calibration functions

3. TECH SPECS

RICO HD SERIES	RS75
SENSOR	
Resolution	1280×1024
Pixel Size	12 μm
Frame Rate	30hz
Image Processing	MATRIX III
Core	iRay Micro II 1280
NETD	≤25 mk
OPTICS	
Objective Lens	75 mm f/1.0
Magnification	2×
Digital Zoom	16×
FOV	11.7° × 9.4°
Detection Range	3600 Yards
Display Type	AMOLED
Display Resolution	2560×2560
Imaging Modes	White Hot, Black Hot, Red Hot, Rainbow, Highlight
Reticle Types	7
Reticle Colors	Black, White, Red, Green
Mounting System	Picatinny MIL-STD 1913 Rail
P.I.P.	Yes
Rangefinder	ILR-1000 Laser Rangefinder
Eye Relief	60 mm
Diopter Range	-3 to +3
ELECTRONICS	
Onboard Recording	Video and Image
Onboard Storage	128 GB
Wireless Connectivity	Image/video via App.
Data/Power Connector	USB-C
Power Supply	IBP-1 Battery ×2, 6 hours
Start Up Time	<10 Seconds, Instant from Standby
PHYSICAL	
Size	12.55" × 3.93" × 3.34"
Weight	44.9 Oz
ENVIRONMENTAL/WARRANTY	
Warranty	5 Years
Housing Material	T-6061 Aluminum
Ingress Protection	IP67
Operation Temperature	-4°F~122°F
Max. Recoil	1000 g/s ² (300 Win./7mm Mag)

4. ACCESSORIES

The RICO HD Series RS75 rifle scope ships with everything you need to get out and hunt.

PART NO.	DESCRIPTION
IRAY-AC05	ILR-1000 Laser Rangefinder Module
IRAY-AC08	USB-C to Analog RCA/USB Cable 36"
IRAY-AC102	Objective Lens Cap for RICO RS75
IRAY-AC103	Shock Reduction Picatinny Mount for RICO RS75
IRAY-AC104	Standard Rubber Eyeguard for RICO RS75
IRAY-AC28	IBP-1 Battery Pack
IRAY-AC29	IBC-1 Battery Charger for IBP-1 Battery
---	USB Power Adapter
---	M5 Screws for Shock Reduction Picatinny Mount
---	Spanner/T15 Tool
---	Hard Case
---	Lens Cloth
---	User Manual



Replacement accessories, including cables, battery packs, and factory mounts are available for purchase. Contact 800-769-7125 or irayusa.com/support.

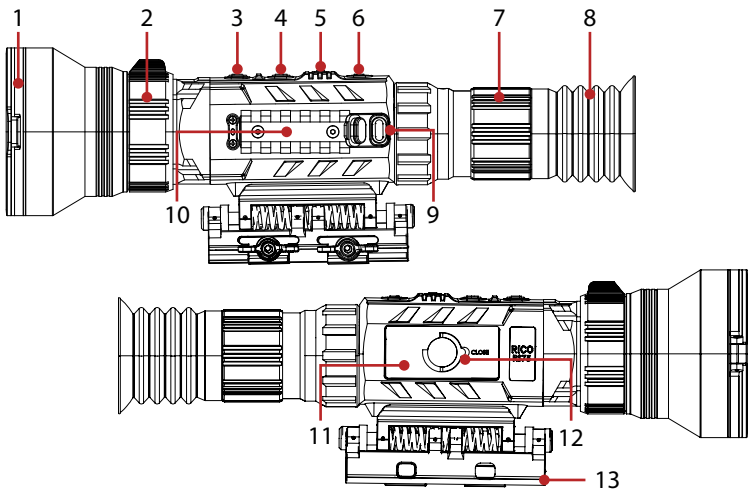

5. COMPONENTS AND CONTROLS





- 1 Objective Lens Cap
- 2 Objective Lens Focus Ring
- 3 Power Button
- 4 Zoom / Up Button
- 5 Menu Button
- 6 Photo / Down Button
- 7 Eyepiece / Diopter Adjustment Ring
- 8 Eyeguard
- 9 USB-C Port
- 10 Accessory Mount (for the included IRL-100 Laser Rangefinder Module)
- 11 IBP-1 Battery Pack
- 12 Battery Pack Pull-Ring
- 13 Shock Reduction MIL-STD-1913 Picatinny Mount

6. DESCRIPTION OF CONTROL BUTTONS AND SHORTCUTS

Power Button 		
Current Screen, Menu, or Device Status	Short Press	Long Press
Device off	---	Power on the device
Home screen	Perform a non-uniformity correction (NUC)	Power off the device
Standby mode	Wake device from standby mode	---
Main menu	Return to previous menu without saving changes (except on/off toggles)	---
Laser rangefinder interface*	Take a single rangefinding measurement in SGL mode	---
Laser calibration interface*	Exit the interface without saving the laser calibration	---
Defective pixel correction interface	Add / remove a defective pixel from the "to be corrected list"	---
Reticle zeroing interface	Exit interface without saving new reticle position	---

Power + Zoom Button  + 		
Current Screen / Menu	Short Press	Long Press
Home screen	Activate / deactivate manual standby mode	---

Zoom / Up Button 		
Current Screen / Menu	Short Press	Long Press
Home screen	Adjust digital zoom	Turn PIP window on / off
Main menu / quick menu	Move cursor up	---
Defect pixel correction, reticle zeroing, and laser calibration interfaces	Move cursor 1 pixel in the positive direction	Move cursor 10 pixels in the positive direction

Zoom / Up + Photo / Down Button  + 		
Current Screen / Menu	Short Press	Long Press
Home screen		Enter laser rangefinder*
Laser rangefinder interface*	Switch between rangefinding modes, CONT and SGL	Exit laser rangefinder
Defective pixel correction interface	Clear all defective pixels at once (short press the buttons twice)	
Reticle zeroing interface	---	Freeze image to keep reticle centered on aiming point; press again to clear



Menu Button 		
Current Screen / Menu	Short Press	Long Press
Home screen	Enter quick menu	Enter main menu
Main menu	Change menu options; enter submenu; or confirm submenu changes and return	Save and return to home screen
Quick menu	Toggle through menu options	Exit quick menu
Laser calibration interface*	Select / deselect calibration options (X, Y, Center, Default)	Save laser calibration and exit
Defective pixel correction interface	Switch between axis of movement (X or Y)	Correct pixel(s) and exit OR cancel pixel correction and exit
Reticle zeroing interface	Switch between axis of movement (X or Y)	Save new reticle position and exit

Photo / Down Button 		
Current Screen / Menu	Short Press	Long Press
Home screen	Take photo	Start / stop recording video
Quick menu / main menu	Move cursor down	---
Defect pixel correction, reticle zeroing, and laser calibration interfaces	Move cursor 1 pixel in the negative direction	Move cursor 10 pixels in the negative direction

Zoom + Menu + Photo Button  +  + 		
Current Screen / Menu	Short Press	Long Press
Home screen	---	Activate / deactivate reticle (Long press for 10 seconds)

* Laser module must be installed.

7. QUICK START GUIDE

Step 1: Preparing to Use the RICO HD Series

1. Compare the box contents to the accessories list and examine each for any shipping damage. See Accessories on page 4.
2. Check the lens to ensure there are no smudges or dirt present. Clean with the included lens cloth, if necessary.
3. Install the eyeguard (8).
4. Charge the battery pack (11) using the included battery pack charger (14) before using the RS75 for the first time. See Charging the Battery Pack on page 10.
5. Insert the battery pack into the battery compartment. See Installing the Battery Pack on page 11.
6. Mount the RS75 to the weapon. See Mounting the RICO HD Series on page 13.

Step 2: Turn On the RS75 and Adjust the Focus

1. Open the objective lens cap (1).
2. Long press the Power  button for 3 seconds to power on the RS75. The InfiRay Outdoor logo will appear.
3. Rotate the diopter adjustment ring (7) of the eyepiece until the interface icons are clearly visible.

WARNING: Do not point the objective lens toward intense energy sources, such as the sun. This may render the electronic components inoperative. The warranty does not cover damage caused by improper operation.



Step 3: Adjust Image Settings in the Quick Menu

Short press the Menu  Button to enter the quick menu to adjust the following settings (see Using the Quick Menu on page 18):



1. Select the imaging mode, white hot, black hot, red hot, rainbow, or highlight. The default is white hot.
2. Select the display brightness, from 1–5. The default is 3.
3. Select the image sharpness, from 1–5. The default is 3.

Step 4: Adjust Device Settings in the Main Menu

1. Long press the Menu  Button to enter the main menu to adjust the following settings, as needed:
 - a. Select the desired non-uniformity correction (NUC) mode, automatic, manual, or background. The default is automatic. See Non-Uniformity Correction on page 20 and Main Menu > Calibration on page 29.
 - b. Turn on the digital compass. See Main Menu > Compass on

- page 29.
- c. Turn on the gravity sensor. See Main Menu > Gravity Sensor on page 30.
 - d. Calibrate the digital compass. See Main Menu > Compass Calibration on page 39.
 - e. Turn on the microphone. See Main Menu > Microphone on page 35.
 - f. Set the date and time. See Settings Menu > Date and Settings Menu > Time on page 40.
 - g. Select the unit of measure, meters or yards. The default is meters. See Settings Menu > Unit on page 41.
2. From the home screen, short press the Zoom  Button to toggle through the four zoom options, 2×, 4×, 8×, and 16×. The real-time amplification number appears in the bottom status bar. See Digital Zoom on page 26.
 3. From the home screen, long press the Zoom  Button to turn on the PIP window. A 2× zoomed image (2× that of the total zoom shown in the status bar) will appear at the top of the screen. See Picture in Picture (PIP) on page 26.

Step 5: Set Up the Reticle and Zero the RS75

1. From the home screen, press and hold the Zoom , Menu , and Photo  Buttons at the same time for 10 seconds to activate the reticle for the first time.
2. Select the zeroing profile, A, B, or C. See Reticle Menu > Zeroing Profile on page 31.
3. Select the reticle type, 1–7. See Reticle Menu > Reticle Type on page 31.
4. Select the reticle color, white, black, red, or green. See Reticle Menu > Reticle Color on page 32.
5. Zero the rifle scope. See Zeroing the RICO HD Series on page 19.
 - a. Select, or customize, a preset zero distance that matches the target distance. See Zeroing Menu > Zero Distance Submenu on page 32.
 - b. Zero the reticle. See Zeroing Menu > Reticle Zeroing on page 33.

8. CHARGING THE BATTERY PACK

The RICO HD Series rifle scope comes with two IBP-1, a long-lasting rechargeable lithium-ion battery packs, each providing 6+ hours of operation. The IBP-1 uses a cam-locking mechanism to ensure quick and secure battery changes in the field. Fully charge the battery pack before using the RICO HD Series for the first time.

Charging with the Battery Charger

1. Insert a battery pack (11) into the battery charger (14). Align the slots (A) on the edge of the battery pack with the pins (B) on the inside of the charger.
2. Connect the small USB-C end of the data cable (15) to the USB-C port (C) on the battery pack charger.
3. Connect the standard USB end of the data cable to:
 - a. The included 5V–2A USB power adapter (16); OR
 - b. Any standard USB 3.0 port on a laptop/computer.
4. During charging, the LED status indicator (D) on the battery pack charger will be solid red.

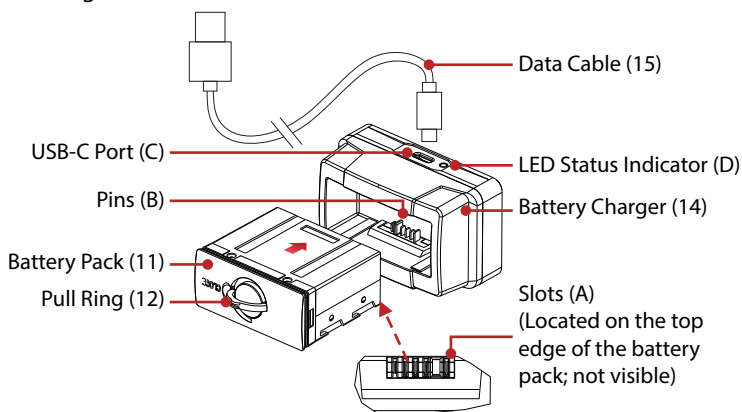

5. When fully charged, remove the battery pack from the battery charger.
 - a. The LED status indicator will turn solid green when the battery is fully charged.
 - b. It takes about 2–3 hours to fully charge the battery. Do not overcharge.

NOTE: When the LED status indicator flashes red, the battery charger is connected to a power source but no battery pack is installed.

WARNING: Never use the battery pack charger with a USB power adapter that is greater than 5V–2A.

Charging via the USB-C Port

1. Connect the small USB-C end of the data cable (15) to the USB-C port (9) on the side of the RS75.
2. Connect the standard USB end of the data cable to:
 - a. The included 5V–2A USB power adapter (16); OR
 - b. Any standard USB 3.0 port on a laptop/computer; OR
 - c. An external power supply, such as a USB power bank.

NOTES:

- You may charge and operate the RS75 at the same time.
- While charging, the battery status icon shown in the status bar onscreen will change to the charging  icon.

9. INSTALLING THE BATTERY PACK

1. Lift the pull-ring (12) on the battery pack (11) and rotate it clockwise 90-degrees until it is horizontal to the battery pack.
2. Position the battery pack face up with the slots (A) facing up.
3. Align the (A) on the edge of the battery pack with the pins (B) on the inside of the battery compartment of the RS75, then slide the battery pack into the opening.

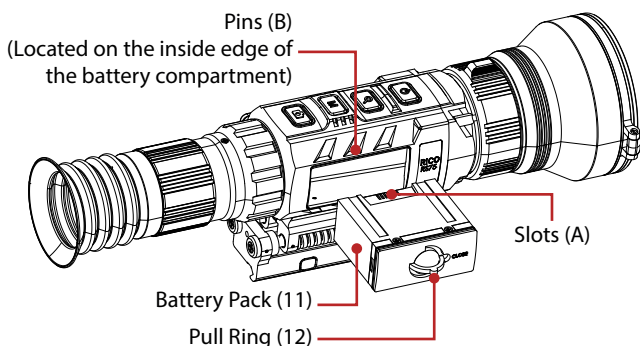

4. Firmly press the battery in to fully insert it.
5. Rotate the pull-ring counterclockwise 90-degrees to the vertical position to lock the battery pack in place.
6. Flip the pull-ring down so that it is flush with the battery pack.

WARNING: The RS75 can only be powered by a factory-supplied IBP-1 battery pack. Using any other battery pack may cause irreparable damage to the rifle scope or cause a fire. Any damage from using an improper battery pack will not be covered by warranty.

10. REMOVING THE BATTERY PACK

To remove the battery pack from the RS75:

1. Lift the pull-ring (12) on the battery pack (11) and rotate it clockwise 90-degrees until it is horizontal to the battery pack.
2. Pull the battery pack out.

11. BATTERY SAFETY WARNINGS

WARNING: Only use the battery charger (14) supplied with the battery pack. The use of any other charger may irreparably damage the battery pack or the charger, and may cause a fire. Any damage from using an improper battery charger will not be covered by warranty.

WARNINGS:

- Do not use a battery charger, power adapter, or USB cable that has been modified or damaged.
- Do not expose the battery to high temperatures or flames, and do not immerse in water.
- Do not leave the battery unattended while charging.
- Do not leave the battery in the charger for long periods after full charge is reached. Charging time should not exceed 24 hours.
- Keep batteries out of the reach of children and pets.
- The battery is equipped with short-circuit protection. However, any situation that may cause short-circuiting should be avoided.
- Do not disassemble, modify, hit, or drop the battery.
- Do not connect the battery to any external device with an electrical current that exceeds permitted levels.
- Do not connect an external device with a current supply that exceeds 3.0 USB port.

To maintain optimal battery capacity and service life:

- Avoid storing a fully charged or discharged battery for long periods. Partial charging the battery is necessary if the battery will be stored for an extended period.
- Do not charge an extremely cold battery without bringing it into a warm environment. Let the battery warm up for 45 minutes before charging.
- Charge the battery at a temperature range from 32°F to 113°F, otherwise the service life of the battery may be reduced.
- The recommended operation temperature range is -4°F to 122°F. Avoid using the battery above the maximum or below the minimum recommended temperature range as this may decrease the battery capacity or service life.

12. EXTERNAL POWER SUPPLY

The RICO HD Series supports the use of an external power supply, such as a 5V mobile power bank.

1. Connect the external power supply to the USB-C port (9).
2. The RS75 will switch to operation from the external power supply, and the battery pack will begin slowly charging.
3. The battery status icon in the status bar will change to a charging battery  icon, with the battery color indicating the current charge level (green, yellow, red). See Battery Status on page 17 for additional information.
4. If the external power supply is disconnected, the RS75 will automatically switch to the battery pack without powering off.

NOTE: Do not connect the RS75 to an external device with a power supply that exceeds the 3.0 USB cable.

13. MOUNTING THE RICO RS75

Installing the Shock Reduction Picatinny Mount

Before using the RICO HD Series, you will need to install the Shock Reduction Picatinny Mount (13) to the three mounting holes (17) in the base of the RS75.

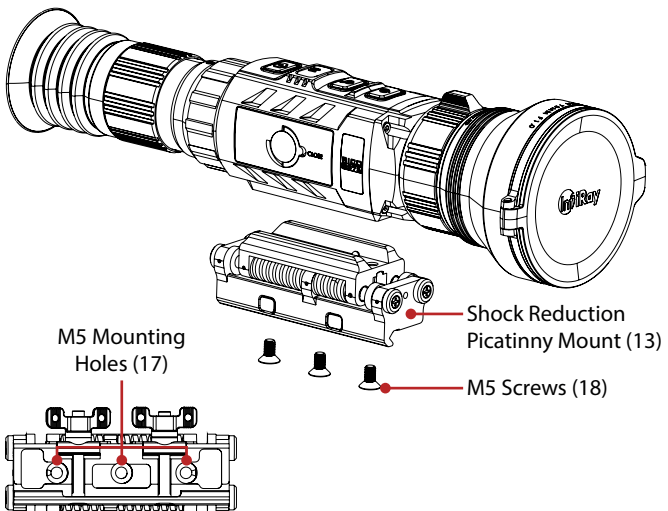

1. Install the Picatinny mount (13) to the base of the RS75 using a 3mm hex key and the M5 screws (18) supplied in the package.
2. Install the RS75 to the rifle so that it produces a clear image and is comfortable to the shooter.

3. When the location is suitable, remove the RS75 from the rifle, remove the M5 screws, and apply a small amount of blue Loctite 242 to the threads of the screws.
4. Reinsert the screws and tighten them to 20 in/lbs.

NOTE: Please note, torque is inch pounds, NOT foot pounds. If you do not have a torque wrench, apply until snug. Do not overtighten.

The RS75 is now ready to be installed to the rifle and zeroed. See Zeroing the RICO Series RS75 on page 19 for instructions.

Adjusting the Mount Tension

Tighten the wing-nuts on the side of the mount with your fingers:

1. Turn the wing-nuts clockwise until snug, then tighten another $\frac{1}{8}$ turn to secure.

14. OPERATING INSTRUCTIONS

WARNING!

Don't point the objective lens towards any intense energy sources, such as laser radiation or the sun. This may render the electronic components inoperative. The warranty does not cover damage caused by improper operation.

Shortcut Buttons

The RICO HD Series is operated via four control buttons. The control buttons can be used to perform shortcut operations from the home screen, as well as in the menu and full-screen interfaces. See Description of Control Buttons and Shortcuts on page 6 for shortcut button details.



Power On / Starting

1. Open the objective lens cap (1).
2. Long press the Power  button for 3 seconds to turn on the rifle scope. The InfiRay Outdoor logo will appear.

To determine the current battery charge, check the battery icon in the top status bar. See Battery Status on page 17.

Powering Off / Stopping

To power off the RS75:

1. Long press the Power  button. The shutdown screen will open, showing a 3-second countdown.
2. Continue holding the Power  button until the 3-second countdown completes.
3. "Data saving..." appears onscreen and the RS75 will shut down automatically after saving.

NOTE: Releasing the Power  Button at any time during this shutdown cycle will stop the shutdown process and the rifle scope will resume its normal operation.

WARNING: If using an external power supply, do not remove the power supply when saving data, otherwise the data may not be saved.

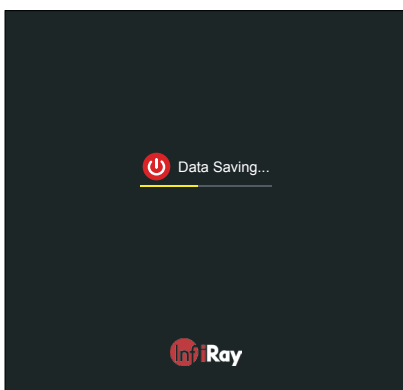
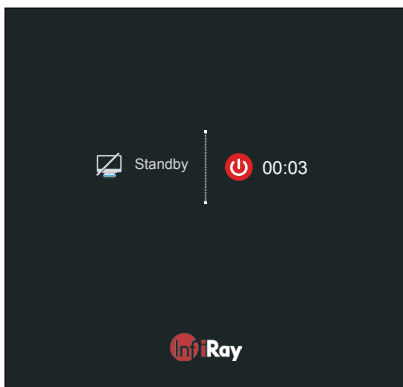



STANDBY MODE

Standby mode may be activated either manually or automatically to conserve battery life.

Automatically Enter / Exit Standby Mode

In the main menu, the RS75 may be set to automatically enter standby mode after a specified time with no operation (2, 4, or 6 minutes).

1. In the main menu, select the desired standby time, 2, 4, or 6 minutes. See Main Menu > Standby on page 36 for instructions.
2. The standby icon  and status (2min, 4min, 6min, or off) appear in the bottom status bar.
3. Once set, the RS75 will automatically enter standby mode, after the set number of minutes of inactivity, to conserve battery life.
4. When in standby mode, short press the Power  Button to exit standby and return to the home screen.



NOTES:

- When 2min, 4min, or 6min is selected:

- The RS75 will enter standby mode automatically when the RS75 is tilted up or down at an angle of more than 70° or left or right at an angle of more than 30°.
- The RS75 will not enter standby mode while it is in a level firing position.
- When off is selected, standby mode is turned off and the rifle scope will operate until the batteries run out.

Manually Enter / Exit Standby Mode

The user may enter standby mode manually at any time.

1. From the home screen, short press the Power  and Zoom  Buttons at the same time to activate / deactivate manual standby mode.

Adjusting the Focus

ADJUSTING THE DIOPTER/EYEPIECE

1. Rotate the eyepiece diopter adjustment ring (7) at the rear of the rifle scope right or left until the user interface onscreen is clear.
2. Look closely to ensure all screen symbols, the status bar, and the reticle appear sharp and in focus. No additional diopter adjustments are required unless the user wishes to make changes.

NOTES:

- After the initial adjustment, there is no need to rotate the eyepiece adjustment ring (7) for long distances or other conditions.
- If necessary during standard use, the objective lens focus ring (2) may be rotated to adjust fine focus on the target object being observed. See Focusing the Objective Lens below.

FOCUSING THE OBJECTIVE LENS



To adjust the focus on the target object:

1. Rotate the objective lens focus ring (2) left or right to adjust fine focus on the target object being observed.

NOTE: Re-adjusting the focus will be necessary if the distance to the target changes.

Activate / Deactivate the Reticle

The reticle is inactive when the RS75 is powered on for the first time. To activate the reticle, or to deactivate it at a later time:

1. From the home screen, press and hold the Zoom , Menu , and Photo  Buttons at the same time for 10 seconds.

Status Bar Overview

The status bars at the top and bottom of the screen show information on the operating status of the RICO HD Series.

TOP STATUS BAR



- 1 Time: Shows the current time in 24-hour format.
- 2 Digital Compass: Displays when the compass is turned on. Compass is off by default.
- 3 Battery: Shows the current battery status.

BOTTOM STATUS BAR





- 4 Imaging Mode: Shows the set imaging mode, white hot ☀️, black hot 🌑, red hot 🔥, rainbow 🌈, and highlight 🐦. White hot is the default.
- 5 Zeroing Profile & Distance: Shows the selected zero profile, A, B, or C, and zero distance.
- 6 Ultra-Clear Mode: Shows the Ultra-Clear status, on 👁️ or off 🚫. Ultra-Clear mode is on by default.
- 7 Total Magnification: Shows the total magnification, 4.0x, 8.0x, 16.0x, 32.0x.
- 8 Non-Uniformity Correction (NUC) Mode: Shows the non-uniformity correction (NUC) mode 📷 icon and selected mode, automatic (A), manual (M), and background (B). Automatic is selected by default. A countdown timer icon will appear instead of the calibration mode when 5 seconds remain until an automatic NUC.
- 9 Standby: Shows standby time 🕒 (2, 4, 6 min) or 🕒 off. Standby is off by default.
- 10 WiFi: Shows the WiFi status, on 📶 or off 🚫. WiFi is off by default.

BATTERY STATUS

Battery icon color indicates the current battery status. The battery icon is replaced by the charging battery icon when an external power supply is connected.

COLOR / ICON	BATTERY STATUS
Green Battery 	41% – 100%

Yellow Battery 	20% – 40%
Red Battery 	<20%; charge the battery pack right away.
Charging Battery 	Battery pack is charging; external power supply or computer is connected via the data cable

Using the Quick Menu

In the quick menu, the imaging mode, display brightness, image sharpness, and zero distance may quickly be adjusted.

1. On the home screen, short press the Menu **[M]** Button to enter the quick menu.
2. Short press the Up / Zoom **[Q]** Button or Down / Photo **[C]** Button to move between the menu options below. The selected menu item is back-highlighted blue.
 - a. Image mode: Short press the Menu **[M]** Button to change the image mode, white hot, black hot, red hot, rainbow, and highlight. The selected imaging mode appears in the bottom status bar.
 - b. Display brightness: Short press the Menu **[M]** Button to change the display brightness level, from 1–5.
 - c. Image sharpness: Short press the Menu **[M]** Button to change the image sharpness level, from 1–5.
 - d. Zero distance: Short press the Menu **[M]** Button to select a new zero distance within the currently selected zeroing profile. Only the zero distances in the selected profile will be available for selection. The selected zeroing distance appears in the bottom status bar.
3. Long press the Menu **[M]** Button to save any changes and return to the home screen.

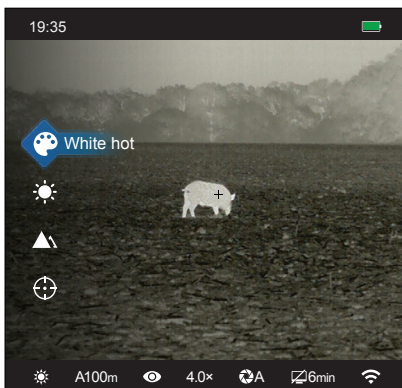

NOTE: If there is no user input for 5 seconds, the RS75 will automatically save any changes and return to the home screen.

Navigating the Main Menu

From the home screen, long press the Menu **[M]** Button to enter the main menu.



In all menu interfaces:

- Short press the Up / Zoom **[Q]** Button or Down / Photo **[C]** Button to move up and down through the menu to switch between the main menu options.
- In the first-level menu, a blue arrow, menu icon, and text indicate the current cursor position. In submenus, the cursor position is indicated by a blue back-highlight.
- Short press the Menu **[M]** Button to:
 - Change the current parameters for the selected menu option; OR
 - Enter the submenu; OR
 - Confirm submenu changes and return to previous menu.
- Long press the Menu **[M]** Button to confirm any changes and exit to the home screen. Changes to toggle on / off menu items, such as Ultra-Clear and WiFi, are saved automatically.
- Short press the Power **[P]** Button to return to the previous menu without saving.
- Upon exiting the main menu the cursor location is stored for a single working session (until the RS75 is turned off). After restarting the RS75 and entering the menu, the cursor position will be at the first menu item.

15. ZEROING THE RICO HD SERIES

RICO HD Series features a “freeze” zeroing method. To zero the RS75:

1. Set a suitable target at the desired zero distance.

2. Confirm that the rifle is empty, safe, and pointed in a safe direction, with no ammunition near the weapon.
3. Adjust the image and device settings following the steps in the Quick Start Guide, if you have not done so already. See Quick Start Guide on page 8.
4. Select the zeroing profile, A, B, or C. See Reticle Menu > Zeroing Profile on page 31.
5. Based on the distance to the target you wish to zero, select a preset zero distance (100m, 200m, 300m, or 109y, 219y, 328y), OR customize one of the preset zero distances to match. The RS75 supports custom zeroing distances of 1 to 999 meters or 1 to 999 yards. See Zeroing Menu > Zero Distance Submenu on page 32.
6. Ensure a stable platform and natural shooting position is achieved behind the rifle.
7. Load ammunition, aim, and take one good shot at the target.
8. Make your rifle safe and observe the location of impact on the target.
9. If the point of impact does not match the point of aim (the center of the reticle), adjust the X/Y position of the reticle. See Zeroing Menu > Reticle Zeroing on page 33.

16. NON-UNIFORMITY CORRECTION

A non-uniformity correction (NUC) allows a thermal imager's sensors to correct its pixels and eliminate any image defects caused by pixel drift. A NUC will be performed automatically each time the RICO HD Series is powered on.

The RS75 has three NUC modes, automatic (A), manual (M), and background (B). The selected NUC mode appears in the in the bottom status bar. For instructions on setting the NUC mode in the main menu, see Main Menu > Calibration on page 29.

Automatic Mode

In automatic mode (A), the RS75 will perform a NUC automatically according to the internal software algorithm. There is no need to close the objective lens cap (1) as the RS75's internal shutter covers the sensor.

A countdown timer will appear in the status bar instead of the calibration mode when 5 seconds remain until an automatic NUC is performed.

Pressing the Power  Button during the 5-second countdown will interrupt a pending NUC for approximately 2 minutes. The timer will appear only after the microbolometer temperature has stabilized—after approximately 10 minutes of continuous operation of the RS75.

NOTE: A manual NUC (see below) may be performed at any time while in Automatic (A) mode.

Manual Mode

In manual mode (M), the user independently determines the need to perform a NUC based on the quality of the observed image. It is not necessary to close the objective lens cap (1) during a manual NUC, as the internal shutter covers the sensor.

To perform a manual NUC while in manual mode (or automatic mode):

1. From the home screen, short press the Power  Button.
2. A manual NUC is performed instantly.

Background Mode

In background mode (B), the user independently determines the need to perform a background NUC based on the quality of the observed image. A background NUC uses less power than an automatic or manual NUC because it does not use the imager shutter to cover the sensor; instead, the user must close the lens cap (1).

To perform a background NUC while in background mode:

1. Close the objective lens cap (1).
2. From the home screen, short press the Power  Button.
3. A prompt to close the lens cap (1) appears onscreen. The background NUC starts after about 4 seconds.

NOTE: If the lens is not properly covered, a temporary “image burn” will remain in the image until the next non-uniformity correction. This “image burn” is temporary and is not a defect or sign of permanent damage.

17. PHOTOGRAPHY AND VIDEO RECORDING

The RICO HD Series is equipped with video recording and image capture.



Photo and video files are named with the time and date; therefore, it is recommended to set the date and time before using the photo and video functions. See Settings Menu > Date and Settings Menu > Time on page 40. Alternately, the date and time may be synchronized with one button in the InfiRay Outdoor App. See Using the InfiRay Outdoor App on page 25.

NOTE: All videos and photos are automatically saved to the RS75’s built-in 128 GB memory storage.





Photography

To take a photo:

1. From the home screen, short press the Photo  Button.
2. The image will freeze for 0.5 seconds and the camera  icon will appear in the upper-left corner of screen.

Video Recording

To record video:

1. Turn on the microphone in the main menu, if desired. See Main Menu > Microphone on page 35.
2. From the home screen, long press the Photo  Button to start a video recording.
3. When the video recording starts, the video recording timer, in HH:MM:SS (hour: minute: second) format, appear in the upper-left corner of the screen.
4. When recording, short press the Photo  Button to take a photo.
5. Long press the Photo  Button to stop and save the video recording.



Video and Photography Tips

- You may enter and navigate the menu as normal during video recording. The user interface (the status bar, icons, and menu) is not captured in recorded video or photo files.
- Recorded photos are saved to the internal memory card of the in .jpg format, videos are saved in .mp4 format.
 - a. Photos are saved in IMG_HHMMSS_XXX.jpg format.
 - b. Videos are saved in VID_HHMMSS.mp4 format.
 - c. HHMMSS is hour/minute/second.
 - d. XXX is a 3-digit counter number.
- The counter used for multimedia file names cannot be reset.
- If a file is deleted from the internal memory, its counter number is not taken by another file.

NOTES:

- The maximum duration of a recorded video file is 10 minutes. After this time, video recording will begin a new file automatically.
- The number of the recorded files is limited only by the capacity of the internal memory.

- Check the available space on the internal storage card regularly and move video footage and images to other storage media to free up space on the memory card.
- Graphic data (icons and menu) are not displayed in recorded video and photo files.

18. ACCESSING THE INTERNAL MEMORY

When the RICO HD Series is turned on and connected to a computer via the included data cable, it is recognized by the computer as a flash memory (USB) drive. This allows the user to access the saved multimedia files and copy or delete any desired files.

To access the internal memory:

1. Turn on the RS75.
2. Plug the smaller USB-C end of the data cable (15) into the USB-C port (9).
3. Plug the larger USB end of the data cable into your computer.
4. Double-click My Computer on your computer desktop.
5. Double-click to open the device named RS75.
6. Double-click to open the device named Internal Storage to access the built-in memory.
 - a. The device shows the available space (in GB) remaining of the total memory storage.
 - b. Recorded photos and videos are separated by date into folders.
 - c. Folders are named by date, in YYYYMMDD (year/month/day) format.
7. Select the desired files or folders to copy or delete.

19. CONNECTING TO WIFI

The RICO HD Series has a function for wireless communication with a mobile device (smartphone or tablet) via WiFi. When WiFi is successfully connected, the user may manipulate the RS75 via the InfiRay Outdoor App. See Using the InfiRay Outdoor App on page 25.

To enable the wireless module:

1. In the main menu, turn on WiFi. See Main Menu > WiFi on page 28 for instructions.



2. When WiFi is on, the WiFi  icon displays in the status bar.

In the InfiRay Outdoor App:

1. Scan one of the QR codes in Using the InfiRay Outdoor App on page 25 to download the InfiRay Outdoor App from the App Store or Google Play.
2. Open the app and press the ViewFinder  icon at the bottom of the screen.
3. The ViewFinder screen will prompt the user to: Open the mobile device > Go to device settings > Turn on device WiFi > Connect to WiFi.
4. Click the Connect Device WiFi button.

On the mobile device:

1. Go to Settings > WiFi.
2. Select the RS75 from the list of WiFi networks. The RS75 will appear in the list as "RS75_XXXXX-XXXXXX", where XXXXX-XXXXXX is the eleven-digit device serial number. See Settings Menu > Info on page 43 for the serial number (SN).
3. Enter the WiFi password. The default password is 12345678.
4. Press the Join button.



Firmware Upgrade

When a firmware update is available, it may be sent to the RS75 through WiFi connection.

To check for and download an available firmware update:

1. On your mobile device, go to irayusa.com/fwpc.
2. If an update is available for the RICO HD Series, it will be listed at the top of the screen (look for your model number: RS75).
3. Click the available update to download it.
4. Confirm you wish to download the file and select where to save the .img file on your mobile device.

To upgrade the RS75:

1. On the RS75, turn on WiFi to connect to the App. See Main Menu > WiFi on page 28.
2. Open the InfiRay Outdoor App.
3. In the App, press the ViewFinder  icon at the bottom of the screen.
4. Press the Settings  icon at top-right.

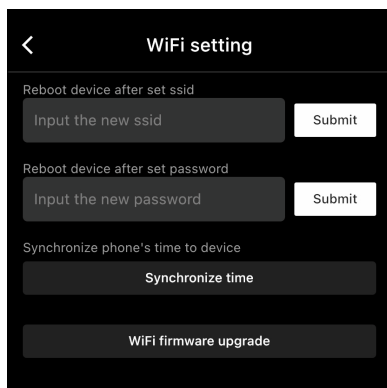



5. Press the WiFi Firmware Upgrade button.
6. Press the Choose Firmware button to browse for the saved .img file on your mobile device.
7. Press the Start Upgrading button. The app will display the current upload progress. The RS75 will automatically reboot when the upgrade has completed.

Setting a New WiFi Password and SSID

The WiFi SSID and password for the RICO HD Series can be reset in the InfiRay Outdoor App. The default password is 12345678.

After connecting with a mobile device:

1. Open the InfiRay Outdoor App.
2. Press the ViewFinder  icon at the bottom of the screen.
3. Press the Settings  icon.
4. In the password field, enter the new WiFi password, and press the Submit button. The password must be 8–16 numbers/letters.
5. If you also wish to reset the SSID, enter a new WiFi name in the SSID field, and press the Submit button.
6. Turn off the RS75 to put the new password (and SSID, if changed) into effect.
7. Wait at least 30 seconds before restarting the device.
8. On the mobile device, go to Settings > WiFi, enter the new password, and press the Join button.

NOTE: When a factory reset is performed, the WiFi SSID and password are reset to the defaults, RS75_XXXXX-XXXXXX AND 12345678. See Settings Menu > Factory Reset on page 42.

20. USING THE INFIRAY OUTDOOR APP



The RICO HD Series rifle scope supports operation via the InfiRay Outdoor App when the RS75 is connected via WiFi to a smartphone or tablet. See Main Menu > WiFi on page 28.

You can download and install the InfiRay Outdoor App for free via any app store, or by scanning one of the QR codes to download the InfiRay Outdoor App from the App Store or Google Play.

When WiFi is connected, users can manipulate the RS75 via the InfiRay Outdoor App, including:

- Take real-time photos and videos, with or without audio.



- Photos and videos taken via the App are saved to the mobile device, instead of the RS75's internal storage. Once connected, you can access files saved to the mobile device:
 - In the App, press the ViewFinder icon  at the bottom of the screen.
 - Press the photo and video icons at the bottom of the screen to view, share, delete, and download photos and videos.
- Change the WiFi password and SSID. See Setting a New WiFi Password and SSID on the previous page.
- Synchronize date and time from the mobile device:
 - In the App, press the ViewFinder icon .
 - Press the Settings icon  at top-right.
 - Click the Synchronize Time button.
- Upgrade the firmware. See Firmware Upgrade on page 24.

21. DIGITAL ZOOM

The RICO HD Series will quickly increase the basic magnification by enlarging the image from 2 to 16 times digitally.

To adjust the digital zoom:

1. From the home screen, short press the Zoom  Button to toggle through the digital zoom levels, 2x, 4x, 8x, and 16x. The total real-time magnification is displayed in the bottom status bar.
2. The following table lists the real-time magnification corresponding to each digital zoom level.



CALCULATING REAL-TIME AMPLIFICATION

Digital Zoom Level	2x	4x	8x	16x
Real-time Magnification	4.0x	8.0x	16.0x	32.0x

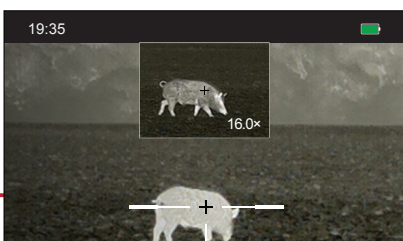

22. PICTURE IN PICTURE (PIP)

The Picture in Picture (PIP) function opens a small floating window with a magnified image-view at the top of the screen. PIP allows for improved



aiming while still being able to see the wide field of view in the main body of the screen.

To activate Picture in Picture mode:

1. From the home screen, long press the press the Zoom  Button. A 2x zoomed image, centered on the reticle, will appear at the top of the screen. Please note that the PIP image is 2x that of the total magnification shown in the bottom status bar.
2. To exit PIP mode, long press the Zoom  Button.

NOTE: When the image in the main body of the screen is enlarged via digital zoom, the PIP image will enlarge accordingly.

23. ULTRA-CLEAR MODE

Ultra-Clear mode improves the image quality in inclement weather conditions, such as rain, fog, high humidity, or high temperatures as these conditions all result in lower thermal contrast. Ultra-Clear mode enhances the NETD value of the thermal sensor and improves the sensor's response rate to these challenging environment conditions.



Ultra-Clear mode provides:

- Improved image quality and clarity; images are crisper and sharper.
- Increased image detail.
- Improved recognition of observed targets.

See Main Menu > Ultra-Clear on page 28.

24. MAIN MENU OPTIONS AND DESCRIPTIONS

Menu, and submenu, options, from top to bottom are:

- Main Menu: Ultra-Clear, WiFi, Calibration, Compass, Gravity Sensor, Reticle, Zeroing, Microphone, Standby, Laser Calibration, Pixel Defect Correction, Compass Calibration, and Settings.
 - Reticle Menu: Zeroing Profile, Reticle Type, and Reticle Color.
 - Zeroing Menu: The three preset Zeroing Distance options (100m, 200m, 300m or 109y, 219y, 328y).
 - Zeroing Distance Submenu: Reticle Zeroing and Custom Zero Distance.

- Settings Menu: Date, Time, Languages, Unit, Status Bar, Factory Reset, and Info.









Menu option details, descriptions and navigation instructions are listed in order on the following pages.

Ultra-Clear

Turn Ultra-Clear mode on / off

When Ultra-Clear mode is turned on, the image contrast is enhanced, which is suitable for rainy, foggy, or low-contrast conditions. See Ultra-Clear Mode on page 27.



1. Long press the Menu  Button to enter the main menu.
2. Short press the Up  or Down  Button to move through the menu to select the Ultra-Clear  menu item.
3. Short press the Menu  Button to turn Ultra-Clear on / off. Ultra-Clear is off by default.
4. The Ultra-Clear status, on  or off , changes in real-time and appears in the bottom status bar.
5. Long press the Menu  Button to return to the home screen.





NOTE: When Ultra-Clear mode is turned on and off, the RS75 will automatically perform a shuttered non-uniformity correction.



WiFi

Turn WiFi on / off

Turn on WiFi to manipulate the RS75 via the InfiRay Outdoor App. See Connecting to WiFi on page 23.



1. Long press the Menu  Button to enter the main menu.
2. Short press the Up  or Down  Button to move through the menu to select the WiFi  menu item.

3. Short press the Menu **[M]** Button to turn WiFi on / off. WiFi is off by default.
4. The WiFi status, on  or off , changes in real-time and appears in the bottom status bar.
5. Long press the Menu **[M]** Button to return to the home screen.

Calibration

Select calibration (non-uniformity correction) mode

The RICO HD Series has three non-uniformity correction (NUC) modes, Automatic (A), Manual (M) and Background (B). See Non-uniformity Correction on page 20 for details about each mode.

1. Long press the Menu **[M]** Button to enter the main menu.
2. Short press the Up **[Q]** or Down **[K]** Button to move through the menu to select the calibration  menu item.
3. Short press the Menu **[M]** Button to enter the calibration submenu.
4. Short press the Up **[Q]** or Down **[K]** Button to move through the calibration submenu options, Automatic (A), Manual (M) and Background (B). Automatic (A) is selected by default.
5. The selected NUC mode, A, M, or B, appears in the bottom status bar.
6. Long press the Menu **[M]** Button to confirm the selection and return to the home screen.







Compass

Turn the digital compass on / off







1. Long press the Menu **[M]** Button to enter the main menu.



2. Short press the Up  or Down  Button to move through the menu to select the compass  menu item.
3. Short press the Menu  Button to turn the digital compass on / off. The digital compass is off by default.
4. The compass status, on or off, changes in real-time. When the compass is on, it appears in the center of the top status bar.
5. Long press the Menu  Button to return to the home screen.

Gravity Sensor





Turn the gravity sensor on / off

1. Long press the Menu  Button to enter the main menu.
2. Short press the Up  or Down  Button to move through the menu to select the gravity sensor  menu item.
3. Short press the Menu  Button to turn the gravity sensor on / off. The gravity sensor is off by default.
4. The gravity sensor status, on or off, changes in real-time. When the gravity sensor is on, the tilt angle appears on the left side of the screen and the pitch angle appears on the right side.
5. Long press the Menu  Button to return to the home screen.



Reticle

Select the zeroing profile, reticle type, and reticle color

1. Long press the Menu  Button to enter the main menu.
2. Short press the Up  or Down  Button to move through the menu to select the reticle  menu item.



3. Short press the Menu **[M]** Button to enter the reticle submenu.
4. There are three submenu items: zeroing profile, reticle type, and reticle color.

RETICLE MENU > ZEROING PROFILE

Select the zeroing profile

1. In the reticle submenu, the zeroing profile  menu item is selected by default.
2. Short press the Menu **[M]** Button to enter the zeroing profile submenu.
3. Short press the Up **[Q]** or Down **[K]** Button to move through zeroing profile options, A, B, C. The default is A.
4. The selected zeroing profile, A, B, or C, appears in the bottom status bar.
5. Long press the Menu **[M]** Button to confirm the selection and return to the home screen.



RETICLE MENU > RETICLE TYPE

Select reticle type

1. In the reticle submenu, short press the Up **[Q]** or Down **[K]** Button to select the reticle type  menu item.
2. Short press the Menu **[M]** Button to enter the reticle type submenu.
3. Short press the Up **[Q]** or Down **[K]** Button to move through reticle type options, 1–7 (see Reticle Types below). The default is reticle type 1. The reticle type changes as the cursor moves through the type options.
4. Long press the Menu **[M]** Button to confirm the selection and return to the home screen.

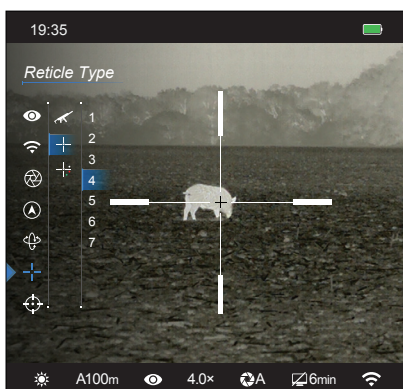







Reticle Types



RETICLE MENU > RETICLE COLOR

Select reticle color

1. In the reticle submenu, short press the Up  or Down  Button to select the reticle color  menu item.
2. Short press the Menu  Button to enter the reticle color submenu.
3. Short press the Up  or Down  Button to move through reticle color options, black, white, red, or green. The default is black. The reticle color changes as the cursor moves through the color options.
4. Long press the Menu  Button to confirm the selection and return to the home screen.

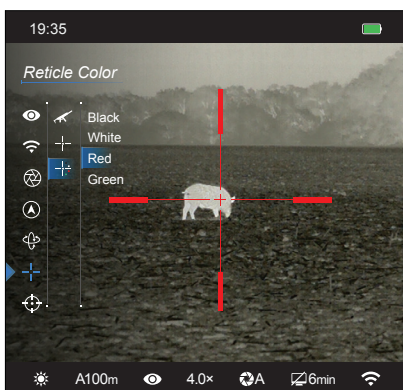

Zeroing





Select or customize zero distance

In the zeroing menu, you can select a preset zero distance, customize a preset zero distance, and adjust the reticle position for the selected zero distance. The RS75 supports custom zero distances of 1 to 999 yards or 1 to 999 meters.



Before selecting or customizing

a zero distance, you must select a zeroing profile, A, B, or C. Each zero profile has three zero distances. See Reticle Menu > Zeroing Profile on page 31.

1. Long press the Menu  Button to enter the main menu.
2. Short press the Up  or Down  Button to move through the menu to select the zeroing  menu item.
3. Short press the Menu  Button to enter the zeroing submenu. There are three zero distances shown in the submenu.

ZEROING MENU > ZERO DISTANCE SUBMENU ^{100m}

Select, or customize, a preset zero distance

1. In the zero distance submenu, short press the

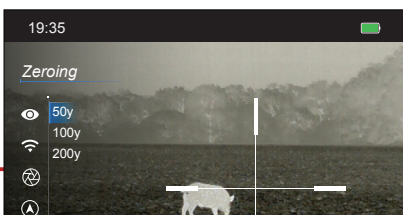

Up **[Q]** or Down **[M]** Button to select a zero distance option. The preset options are 100m, 200m, and 300m (109y, 219y, or 328y).

2. Short press the Menu **[M]** Button to enter the submenu for the selected zero distance.
3. In the submenu for the selected zero distance, you may:
 - a. Enter the reticle zeroing interface  to adjust the X/Y position of the reticle at the selected zero distance. See Reticle Zeroing below.
 - b. Customize the selected preset zero distance, if desired. See Zeroing Menu > Customize Zero Distance on page 35.

ZEROING MENU > ZERO DISTANCE SUBMENU > RETICLE ZEROING

Adjust the reticle position of the selected zero distance.

When zeroing the RS75, if the point of impact does not match the point of aim (the center of the reticle), the X/Y position of the reticle may be adjusted. See Zeroing the RICO HD Series on page 19 for more details.

1. In the submenu for the selected zero distance, the reticle zeroing  menu item is selected by default. Short press the Menu **[M]** Button to select and enter the reticle zeroing interface.
2. The reticle zeroing interface has the following features:
 - 1 X: Horizontal point of impact change (in cm or inches).
 - 2 Y: Vertical point of impact change (in cm or inches).
 - 3 Freeze Icon: Indicates that the image is frozen.
 - 4 Reticle: Shows the new reticle position.
 - 5 White Dot: Indicates the center of the initial reticle position.

NOTE: The red "X" indicates the point of impact. It is shown in the figure for illustration purposes, and is not an interface element.

3. Center the reticle on the aiming point and long press the Zoom **[Q]** and

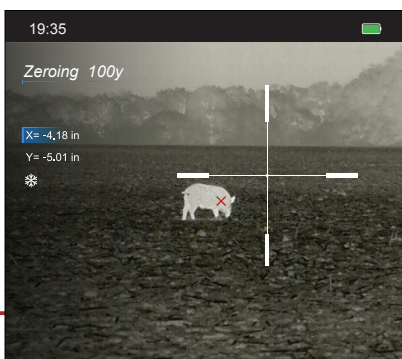











Photo  Buttons at the same time to freeze the image. The image freeze  icon will appear below the X/Y coordinates.

4. Select the axis (X or Y) along which to move the cursor:
 - a. Short press the Menu  Button to toggle between X and Y. The selected axis is indicated by a blue back-highlight. X is selected by default.
5. Adjust the X/Y position of the reticle until the reticle matches the point of impact.

- a. X (horizontal) is the windage and Y (vertical) is the elevation.
- b. Upon moving the reticle, a white dot appears onscreen, representing the original position of the reticle.
- c. Use the Up  Button to move in the positive direction: X= Right and Y= Up.









- d. Use the Down  Button to move in the negative direction: X= Left and Y= Down.
 - e. Short press the Up  or Down  Button to move the reticle in the corresponding direction by 1 pixel; long press to move 10 pixels.
 - f. When adjusting your zero at a distance of 50 yards, short press will change the impact point by 0.29" and long press moves 2.89" as shown in the X and Y coordinate displays. At 100 yards that same short press moves 0.58" and long press moves 5.78". At 200 yards a short press moves 1.16" and a long press moves 11.56".
 - g. Changing your zero distance will change the distance of your X/Y adjustments automatically. If your selected zero distance has a correction of 1.73" at 100 yards, it will automatically change to 3.47" if you change the zero distance to 200 yards.
6. Save OR clear the reticle position along the selected axis.
 - a. Short press the Power  Button to clear the reticle position for the selected axis, returning the reticle to the original position for that axis; OR
 - b. Short press the Menu  Button to save the position for the selected axis and deselect it. The axis will stop flashing.
 7. Long press the Menu  Button to save the reticle position for both axes and return to the home screen.
 - a. A 5-second countdown appears on the screen, followed by "Saved Successfully."

- Take a confirmation shot—the point of impact should now match the point of aim. If not, adjust the X/Y position of the reticle again.

ZEROING MENU > ZERO DISTANCE SUBMENU > CUSTOMIZE ZERO DISTANCE

Customize a preset zero distance



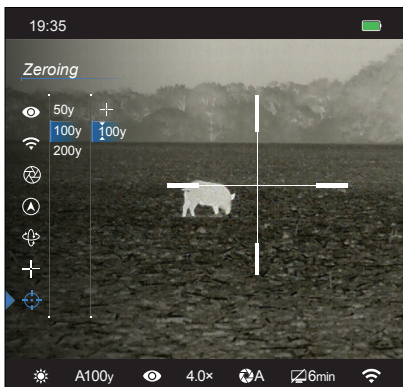

The RICO HD Series supports custom zero distances of 1 to 999 yards or 1 to 999 meters.

- In the submenu for the selected zero distance, short press the Up  or Down  Button to move to the zero distance you wish to customize.
- Short press the Menu  Button to select the preset zero distance. White triangle icons will appear above and below the selected digit to mark the cursor location. The far-left digit is selected by default.
- Short press the Up  or Down  Button to increase or decrease the value of the selected digit, from 0–9.
- Short press the Menu  Button to switch between the three digits. The two triangle icons will indicate the selected digit.
- Long press the Menu  Button to save the custom zero distance and return to the zero distance submenu.
- The new zeroing distance appears in the bottom status bar.





Microphone

Turn the microphone on / off

- Long press the Menu  Button to enter the main menu.
- Short press the Up  or Down  Button to move through the menu to select the microphone  menu item.
- Short press the Menu  Button to turn the microphone on / off. The microphone is off by default.













- When the microphone is on, the microphone on  icon appears in the upper-right corner of the screen.
- Long press the Menu  Button to return to the home screen.

Standby

Set standby status and time



To conserve battery, the RS75 may be set to automatically enter standby mode after a specified number of minutes of inactivity (2, 4, or 6 minutes).

- Long press the Menu  Button to enter the main menu.
- Short press the Up  or Down  Button to move through the menu to select the standby  menu item.
- Short press the Menu  Button to enter the standby submenu.
- Short press the Up  or Down  Button to move through the standby submenu options, 2min, 4min, 6min, or off. Standby is off by default.
- The standby status changes in real-time and the  icon and status (2min, 4min, 6min, or off) appear in the bottom status bar.
- Long press the Menu  Button to confirm the selection and return to the home screen.
- When 2, 4, or 6 minutes is selected, the RS75 will automatically enter standby mode, after the set number of minutes of inactivity, to conserve battery life.
- When in automatic standby mode, short press the Power  Button to exit standby and return to the home screen.

NOTES:

- When 2min, 4min, or 6min is selected:
 - The RS75 will enter standby mode automatically when the RS75 is tilted up or down at an angle of more than 70° or left or right at an angle of more than 30°.
 - The RS75 will not enter standby mode while it is in a level firing position.



- When off is selected, standby mode is turned off and the rifle scope will operate until the batteries run out.
- Standby mode may be manually activated from the home screen at any time:
 - Short press the Power  and Zoom  Buttons at the same time to activate / deactivate manual standby mode.

Laser Calibration





The laser rangefinder function of the RICO HD Series RS75 requires an ILR-1000 Module. Please consult the documentation included with your ILR-1000 for more information on its operation.



Pixel Defect Correction

Select and correct defective pixels

Defective pixels are pixels that do not change correctly compared to the other image pixels—they are either brighter or darker than surrounding pixels. The RICO HD Series has a tool which corrects any defective pixels on the sensor using its internal software.

1. Long press the Menu  Button to enter the main menu.
2. Short press the Up  or Down  Button to move through the menu to select the pixel defect correction  menu item.
3. Short press the Menu  Button to enter the defective pixel correction interface.
4. The pixel correction interface has the following features:

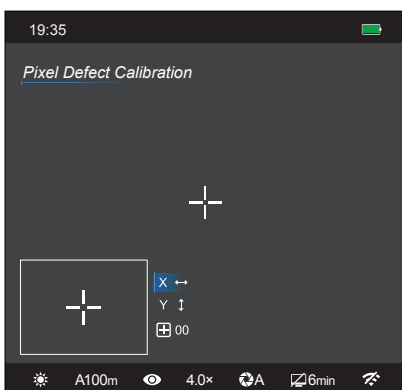
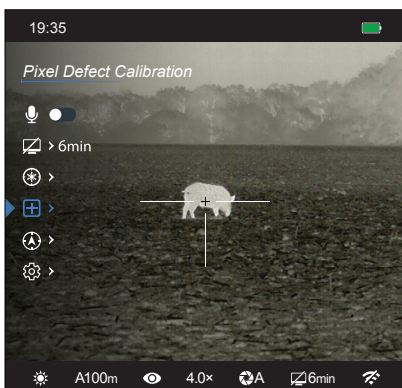

- 1 Cursor: Cursor appears in the center of the screen in place of the reticle. Move the cursor to the position of the defective pixel.

- 2 X: Select to move the cursor horizontally.
- 3 Y: Select to move the cursor vertically
- 4 PIP Window: The Picture in Picture window appears in the lower-left corner.
- 5 00: Shows the number of defective pixels in the "to be corrected" list.

5. To correct all defective pixels at once, short press the Zoom and Photo Buttons at the same time TWICE.

To select and correct defective pixels individually:

6. Select the axis (X or Y) along which to move the cursor:
 - a. Short press the Menu Button to toggle between X and Y. The selected axis is indicated by a blue back-highlight. X is selected by default.
7. Move the cursor along the selected axis to the location of the defective pixel:
 - a. Use the Up Button to move in the positive direction: X= Right and Y= Up.
 - b. Use the Down Button to move in the negative direction: X= Left and Y= Down.
 - c. Short press the Up or Down Button to move the cursor in the corresponding direction by 1 pixel; long press to move 10 pixels.
8. Repeat steps 6–7 to move the cursor along the second axis.

9. With the cursor in position and the second axis still selected, short press the Power Button to add the defective pixel to the "to be corrected list."

- a. Add will briefly appear in the bottom-right corner of the PIP window.
- b. 00 will change to 01 to indicate that one pixel has been added to the correction list.

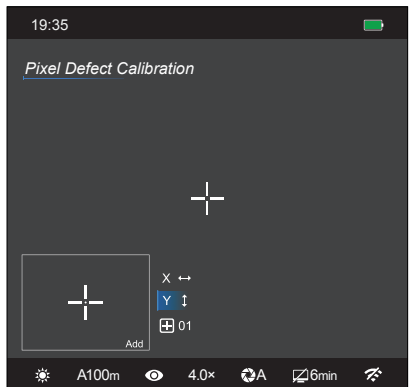

10. If the defective pixel has been added in error, short press the Power Button a second time from the same X/Y coordinates (do not move the cursor) to remove the pixel from the "to be corrected list." Del will briefly appear in the PIP window.

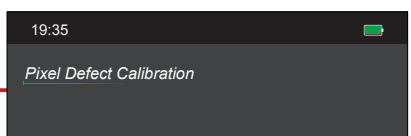

11. Repeat steps 6–9 to add additional defective pixels, if needed.
12. When all defective pixels have been added to the list, long press the Menu **[M]** Button to confirm changes.
13. A popup window shows the message “Do you want to keep these settings?” and two options, Yes and No. Yes is selected by default.
14. Short press the Menu **[M]** Button to select Yes to correct the list of defective pixels and exit to the home screen; OR
 - a. A 5-second countdown appears on the screen, followed by “Saved Successfully” and the device returns to the home screen.
15. Short press the Up **[Q]** or Down **[R]** Button to move to No and short press the Menu **[M]** Button to exit to the main menu without correcting any defective pixels.

NOTE: The PIP window and interface controls will move to the upper-left corner of the screen when cursor moves into the lower-left corner.

Compass Calibration

Calibrate the digital compass

1. Long press the Menu **[M]** Button to enter the main menu.
2. Short press the Up **[Q]** or Down **[R]** Button to move through the menu to select the compass calibration  menu item.
3. Short press the Menu **[M]** Button to begin compass calibration.
4. A triaxial coordinate icon prompt will appear on the screen.
5. Follow the icon prompt to rotate the RS75 at least 360 degrees along each axis, X, Y, and Z. Rotations must be completed within the 15-second calibration time.



- After 15 seconds, the calibration is finished and the RS75 will automatically exit to the home screen.

Settings

Adjust the general settings

- Long press the Menu **[M]** Button to enter the main menu.
- Short press the Up **[Q]** or Down **[K]** Button to move through the menu to select the settings  menu item.
- Short press the Menu **[M]** Button to enter the settings submenu.
- There are seven submenu items: date, time, languages, unit, status bar, factory reset, and info.



SETTINGS MENU > DATE

Set the date

- In the settings submenu, short press the Up **[Q]** or Down **[K]** Button to select the date  menu item.
- Short press the Menu **[M]** Button to edit the date. White triangle icons will appear above and below the selected date value. The year value is selected by default. The date is displayed in YYYY.MM.DD format.
- Short press the Up **[Q]** or Down **[K]** Button to select the correct value for each digit (year, month, and day).
- Short press the Menu **[M]** Button to switch between digits. The two triangle icons indicate the selected digit.
- Long press the Menu **[M]** Button to save the date and return to the home screen.



SETTINGS MENU > TIME

Set the time

- In the settings submenu, short press the Up **[Q]** or Down **[K]** Button to select the time  menu item.

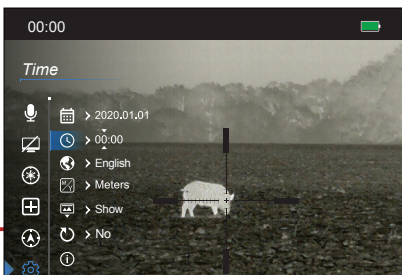

2. Short press the Menu **[M]** Button to edit the time. White triangle icons will appear above and below the selected time value. The hour value is selected by default. The time is displayed in HH.MM, in 24-hour format.
3. Short press the Up **[Q]** or Down **[K]** Button to select the correct value for each digit (hour and minute).
4. Short press the Menu **[M]** Button to switch between digits. The two triangle icons indicate the selected digit.
5. Long press the Menu **[M]** Button to save the time and return to the home screen.
6. The set time appears in the top status bar.

SETTINGS MENU > LANGUAGES

Select the language

1. In the settings submenu, short press the Up **[Q]** or Down **[K]** Button to select the languages  menu item.
2. Short press the Menu **[M]** Button to enter the languages submenu.
3. Short press the Up **[Q]** or Down **[K]** Button to move through the language options, English, German, and Russian. English is selected by default.
4. Long press the Menu **[M]** Button to confirm the selection and return to the home screen.



SETTINGS MENU > UNIT

Set the unit of measurement

1. In the settings submenu, short press the Up **[Q]** or Down **[K]** Button to select the unit  menu item.
2. Short press the Menu **[M]** Button to enter the unit submenu.
3. Short press the Up **[Q]** or Down **[K]** Button to move through unit options, meters and yards. Meters are selected by default.
4. The selected units, m (meters) or y (yards), will display, along with the selected zero profile and distance, in the bottom status bar.



5. Long press the Menu **[M]** Button to confirm the selection and return to the home screen.

SETTINGS MENU > STATUS BAR

Turn status bar auto hiding on / off

This function enables automatic hiding of all interface information, aside from the reticle, for unobstructed image-view.

When auto-hide is turned on, after 8 seconds of inactivity the status bar, digital compass, and all interface icons will be automatically hidden. Shortcut buttons and the menu are disabled until the entire interface is again displayed. Press any button to show all interface information again.



NOTE: When the menu is open, the status bar will not auto-hide.

1. In the settings submenu, short press the Up **[Q]** or Down **[K]** Button to select the status bar  menu item.
2. Short press the Menu **[M]** Button to enter the status bar submenu.
3. Short press the Up **[Q]** or Down **[K]** Button to move through status auto hiding options, show and hide. When show is selected, auto-hiding the status bar is off. Show is selected by default.
4. Long press the Menu **[M]** Button to confirm the selection and return to the home screen.

SETTINGS MENU > FACTORY RESET

Restore factory default settings

1. In the settings submenu, short press the Up **[Q]** or Down **[K]** Button to select the factory reset  menu item.
2. Short press the Menu **[M]** Button to enter the factory reset submenu.
3. Two options, Yes and No, appear; Yes will restore factory settings and No will cancel the operation. No is selected by default.



4. Short press the Menu **[M]** Button to confirm cancellation of the factory reset and return to the submenu; OR
5. Short press the Up **[Q]** or Down **[K]** Button to move to Yes and short press the Menu **[M]** Button to select Yes to confirm the factory reset. Factory settings will be restored and the RS75 will reboot automatically.

NOTES:

- There is a short pause before the factory restart begins. Do not press any buttons during this time.
- A factory reset cannot be undone.
- The settings listed below will be reset to the factory defaults:
 - Imaging mode: White hot
 - Display Brightness: 3
 - Image Sharpness: 3
 - Magnification: 2×
 - Ultra-Clear mode: On
 - WiFi: Off
 - Calibration: Automatic
 - Digital Compass: Off
 - Gravity Sensor: Off
 - Zeroing Profile: A
 - Reticle Type: 1
 - Reticle Color: Black
 - Microphone: Off
 - Standby: Off
 - Date: 2020:01:01
 - Time: 00:00
 - Language: English
 - Status Bar: Show
 - WiFi SSID: RS75_XXXXX-XXXXXX
 - WiFi Password: 12345678

SETTINGS MENU > INFO ⓘ

Show device information

1. In the settings submenu, short press the Up **[Q]** or Down **[K]** Button to select the info ⓘ menu item.
2. Short press the Menu **[M]** Button to enter the info submenu.
3. The info submenu will display the following information about the RS75: the product model, GUI version, SYS Info, boot version, SW, PN, and SN numbers, hardware version, and FCC ID.



4. Long press the Menu **M** Button to exit and return to the home screen.

25. BASIC INSPECTION

It is recommended to carry out a technical inspection before each use. Please check the following:

- The rifle scope appearance: there should be no cracks in the body, or visible damage.
- The condition of the objective lens and eyepiece: there should be no cracks, greasy spots, dirt or other deposits on the lens.
- The internal rechargeable battery pack should be fully charged.
- The control buttons should be in working order.

26. BASIC MAINTENANCE

Always replace the objective lens cap (1) after use to avoid damaging or scratching the lens. Never touch the lens directly; oil from your skin can damage the lens coating and surface.

Basic maintenance should be carried out at least twice a year and includes the following steps:

- Wipe the surface of external metal and plastic components with a clean, dry cotton cloth. Do not use chemical, corrosive, or abrasive cleaners. Canned air may also be used to clean the external components.
- Clean the electric contacts and battery slots on the rifle scope using a non-greasy organic solvent.
- Check the lens and eyepiece. If necessary, remove any dirt or sand from the optics; a non-contact cleaning method is preferred.
- Cleaning the exterior of the lens should only be done with the included microfiber lens cloth or similar product. Only clean the lens when it is visibly soiled. Frequent wiping or cleaning can degrade the anti-reflective lens coating.

27. WARRANTY

At iRayUSA we're first and foremost hunters and users of our products and we understand that failure isn't an option. We also understand that having to wait extended periods for repair isn't something that a customer should have to put up with when something does go wrong. During your published warranty period, iRayUSA will repair or replace, at its discretion, any optic that becomes defective during normal use. Additionally, if we cannot fix your optic in less than one week, we will offer to replace it with a replacement product in like or better

condition. If you would rather wait for your specific optic to be repaired, we can handle that too.

We know you've never seen this from a thermal manufacturer, neither have we, and that's why we started iRayUSA.

Our warranty follows the product, and is not tied to the original owner. The warranty period is tied to the date of sale to the dealer. This warranty only covers normal use and does not cover cosmetic damage, normal wear, intentional damage, theft, loss, any act of God, or a condition caused by use other than intended. Any product that is modified, opened, or tampered with will void any warranty coverage. Any serial number damage or alteration on the product will be considered modification. Be sure to register your RICO HD Series rifle scope at irayusa.com/register.

To return a product for repair:

1. Go to irayusa.com/warranty and click the Request an RMA button to request an RMA number. Returns will not be accepted without an RMA.
2. The customer is responsible for shipping the product to iRayUSA, to the address below. iRayUSA will return the product at no cost.

iRayUSA
800 Railhead Road #316
Fort Worth, TX 76106

- The one-week timeline starts from the time of receipt of product at iRayUSA.
- iRayUSA is not liable for any damages or loss incurred when shipping to iRayUSA.
- This warranty gives you specific legal rights, and you may also have other rights which vary from state to state.

Please give us a call at 800-769-7125, visit irayusa.com/warranty, or email info@irayusa.com with any questions.

28. GENERAL TROUBLESHOOTING

The troubleshooting table on the next page lists issues that may occur when operating the RICO HD Series. Carry out the recommended troubleshooting steps in the order shown in the table. Please contact iRayUSA at 800-769-7125 or irayusa.com/support or an authorized vendor for assistance before attempting to perform any modifications or repairs beyond the scope of the troubleshooting procedures in this manual. Unauthorized repairs or modifications will void your warranty.

ISSUE	POSSIBLE CAUSES
The RS75 will not turn on.	The IBP-1 battery pack is very low or has completely discharged.
The RS75 can not connect to a computer or external power supply.	External power supply has completely discharged.
	Computer is turned off.
	Data cable is damaged.
The RS75 can not connect to the mobile device (smartphone or tablet).	WiFi is not turned on.
	Wrong WiFi password entered.
	Too many WiFi signals near the RS75.
WiFi signal is lost or interrupted.	Smartphone or tablet is out of range of a strong WiFi signal, or there are obstacles between the RS75 and the mobile device.
The image is fuzzy, not clear, not balanced, with artifacts.	Non-uniformity correction is required.
The image is too dark.	Display brightness level is too low.
The GUI is clear, but the image is fuzzy.	The lens is not focused.
	There is dust on the interior or exterior optical surfaces of the lens.
	There is condensation on the interior or exterior optical surfaces of the lens.
The aiming reticle shifts after firing rounds.	The RS75 is not mounted securely or the mount is not secured on the RS75.
The image of the object being observed is missing.	Looking through glass.
The RS75 will not focus.	Image settings are not optimal for the current environmental conditions or the object being observed.
Image quality is too low or the detection range is reduced.	These issues may occur due to the weather conditions, such as snow, rain, humidity, and fog.
When the RS75 is used in low temperature conditions, the image quality of the surroundings is worse than in warm temperature conditions.	Environmental conditions.

TROUBLESHOOTING STEPS

Charge the IBP-1 battery pack.

Check the external power supply and charge it if necessary.

Power on the computer.

Replace the data cable.

Turn on the WiFi in the main menu. See Main Menu > WiFi on page 28

On the mobile device, go to Settings > WiFi and enter the correct password. The default password is 12345678. See Main Menu > WiFi on page 28.

Move the RS75 and mobile device to an area with no or fewer WiFi signals.

- Try again when WiFi signal is stable.
- Relocate the RS75 closer to the WiFi signal.

Perform a non-uniformity correction. See Non-uniformity Correction on page 20 and Main Menu > Calibration on page 29.

Adjust the display brightness in the quick menu. See Using the Quick Menu on page 18.

- Adjust the focus on the target by rotating the Objective Focus Ring (2)
- Adjust the image sharpness in the quick menu. See Using the Quick Menu on page 18.

• Wipe the outside optical surfaces with the included microfiber lens cloth.

- Wipe the outside optical surfaces with the included microfiber lens cloth.
- Allow the RS75 to dry by leaving it in a warm, dry environment for at least 4 hours.

- Check that the RS75 has been securely mounted.
- Make sure you are using the same brand, type, and weight of the bullets as when the RS75 and weapon were initially zeroed.
- If the RS75 was zeroed in different environmental conditions, a slight shift of the zero is possible.

Remove any glass windows from the field of view.

- Check the outer surfaces of the objective lenses and eyepiece and, where necessary, wipe away any dust, condensation, frost, etc.
- In cold weather, you can use special anti-fogging coatings, such as those made as for corrective glasses.
- Adjust the focus on the target by rotating the Objective Focus Ring (2).
- Adjust the image sharpness in the quick menu. See Using the Quick Menu on page 18.
- Adjust the image and device settings. See Quick Start Guide on page 8.
- Turn on Ultra-Clear mode. See Main Menu > Ultra-Clear on page 28.

Turn on Ultra-Clear mode. See Main Menu > Ultra-Clear on page 28.

In warm temperature conditions, objects being observed (surroundings and background) heat up differently because of thermal conductivity, thereby generating a high temperature contrast. Accordingly, image quality produced by the rifle scope will be higher. In low temperature conditions, the background will cool down to roughly the same temperature, and thus the temperature contrast is substantially reduced and image detail can go down as there is less contrast in the scene. This is a normal function of a thermal imager and is no indicator of actual detector performance.

